

ZANUSSI

**Washing Machine
TJS1397W**

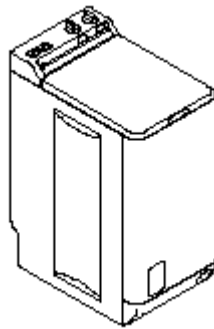

INSTRUCTION BOOKLET



Important Safety Information

It is most important that this instruction book should be retained with the appliance for future reference. Should the appliance be sold or transferred to another owner, or should you move house and leave the appliance, always ensure that the book is supplied with the appliance in order that the new owner can get to know the functioning of the appliance and the relevant warnings.

These warnings have been provided in the interest of safety. You **MUST** read them carefully before installing or using the appliance.

Installation

- This appliance is heavy. Care should be taken when moving it.
- It is dangerous to alter the specifications or attempt to modify this appliance in any way.
- All packaging and transit bolts must be removed before use. Serious damage can occur to the product and to property if this is not adhered to. See relevant section in instructions.
- Any plumbing work required to install this appliance should be carried out by a qualified plumber or competent person.
- Any electrical work required to install this appliance should be carried out by a qualified electrician or competent person.
- Care must be taken to ensure that the appliance does not stand on the electrical supply cable.
- If the machine is situated on a carpeted floor, please adjust the feet in order to allow air to circulate freely.

Child Safety

- This appliance is designed to be operated by adults. Children should not be allowed to tamper with the controls or play with the appliance.
- Pets and children have been known to climb into washing machines. Please check your drum before use.
- Keep all packaging well away from children.
- Keep all detergents in a safe place out of children's reach.

Use

- Always unplug the appliance and turn off the water supply after use.
- Do not overload the appliance. See relevant section in the instruction book.
- Only wash fabrics which are designed to be machine washed. If in doubt, consult the care label on the clothes.
- Before washing, ensure that all pockets are empty and buttons and zips are fastened. Avoid washing frayed or torn articles and treat stains such as paint, ink, rust, and grass before washing. Underwired bras must **NOT** be machine washed.
- Any objects such as coins, safety pins, nails, screws, stones or any other hard, sharp material can cause extensive damage and must not be placed into the machine.
- Garments which have been in contact with volatile petroleum products should not be machine washed. If volatile cleaning fluids are used, care should be taken to ensure that the fluid is removed from the garment before placing in the machine.
- Wash small items such as socks, laces, washable belts etc in a washing bag or pillow case as it is possible for such items to slip down between the tub and the inner drum.
- Only use the advised quantities of fabric softener. Damage to the fabric can ensue if you over-fill. Refer to the manufacturer's recommendations of quantities.
- As some duvets and eiderdowns should be washed in large commercial machines because of their bulk, please check with the manufacturer of the item before washing in a domestic machine.
- Under no circumstances should you attempt to repair the machine yourself. Repairs carried out by inexperienced persons may cause injury or serious malfunctioning. Contact your local Zanussi Service Force Centre. Always insist on genuine Zanussi spare parts.

Contents

For the User

Important Safety Information	3
Your New Washing Machine	5
Description of the Appliance	6
Detergent Dispenser	6
The Control Panel	7
Operating Sequence	8-9
Before use	8
Load the laundry	8
Measure out the detergent	8
Measure out the fabric softener	8
Select the required option	8
Select the required spin speed	9
Select the required programme	9
Start the machine	9
At the end of the programme	9
Washing Hints	10-11
Which detergent ? ...	11
And in which form ?	11
Wash Care Symbols	12
Washing programmes	13-14
Maintenance and Cleaning	15-16
Descaling	15
After each wash	15
External cleaning	15
Cleaning the detergent dispenser	15
Cleaning the drain filter	15-16
The dangers of freezing	16
Something Not Working	17
Service and Spare Parts	18
Peace of Mind for Twelve Months	19

For the Installer

Installation Instructions	20
Technical Specifications	20
Unpacking	21
Positioning	21
Levelling	22
Moving the appliance	22
Special conditions	22
Water inlet	23
Water drainage	23
In the interest of the environment	??
Electrical connection	24

Guide to use the Instruction Book

The following symbols will be found in the text to guide you throughout the instructions:

 Safety instructions

 Hints and tips

 Environmental information

Your New Washing Machine

Your new washing machine meets all modern requirements for effective treatment of laundry with low water, energy and detergent consumption.

Ecological hints

To save water and energy and help protect the environment, we recommend that you follow these hints:

- Adjust the quantity of detergent according to the hardness of your water supply, the amount of laundry and the degree of soiling.
- A programme without prewash is sufficient for normally soiled laundry.

In the interest of the environment

- Materials marked with the symbol  are recyclable.
- Check with your local Council or Environmental Health Office to see if there are facilities in your area for re-cycling this appliance.
- When the appliance is to be scrapped, cut off the power supply cable and make the door lock device unusable to prevent young children from being trapped inside.
- Help to keep your country tidy - use authorised disposal sites for your old appliance.

**How do we help to protect the environment?
We use recycled paper!**



Important

Your machine is fitted with a balance control device, which ensures the machine is stable during the spin. If the wash load appears not to have been spun sufficiently at the end of the wash cycle, because, it is not evenly distributed in the drum, the balance control device may have operated. It will therefore be necessary to redistribute the wash load manually and select a spin programme. For more detailed information see the section headed "Something Not Working".

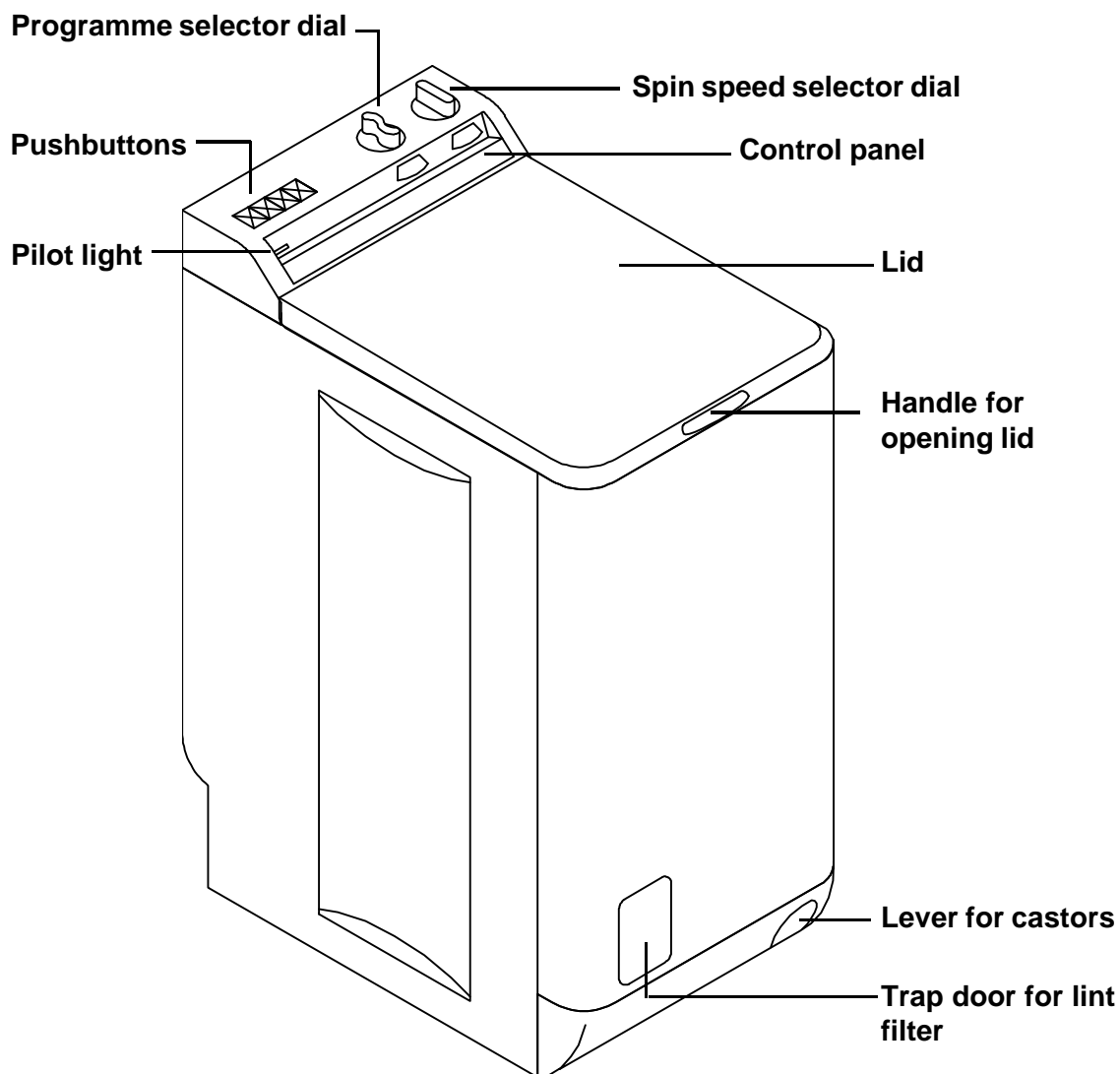
Description of the Appliance



Detergent Dispenser

- 1 Detergent compartment for pre-wash 
- 2 Detergent compartment for main wash 
- 3 Fabric softener 

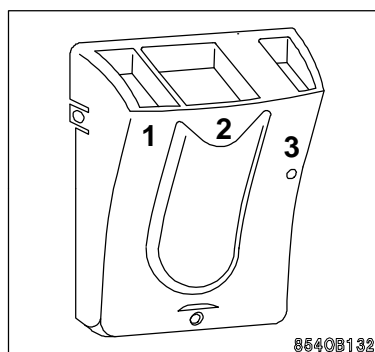

The Control Panel

Never turn the programme selector when the appliance is working.

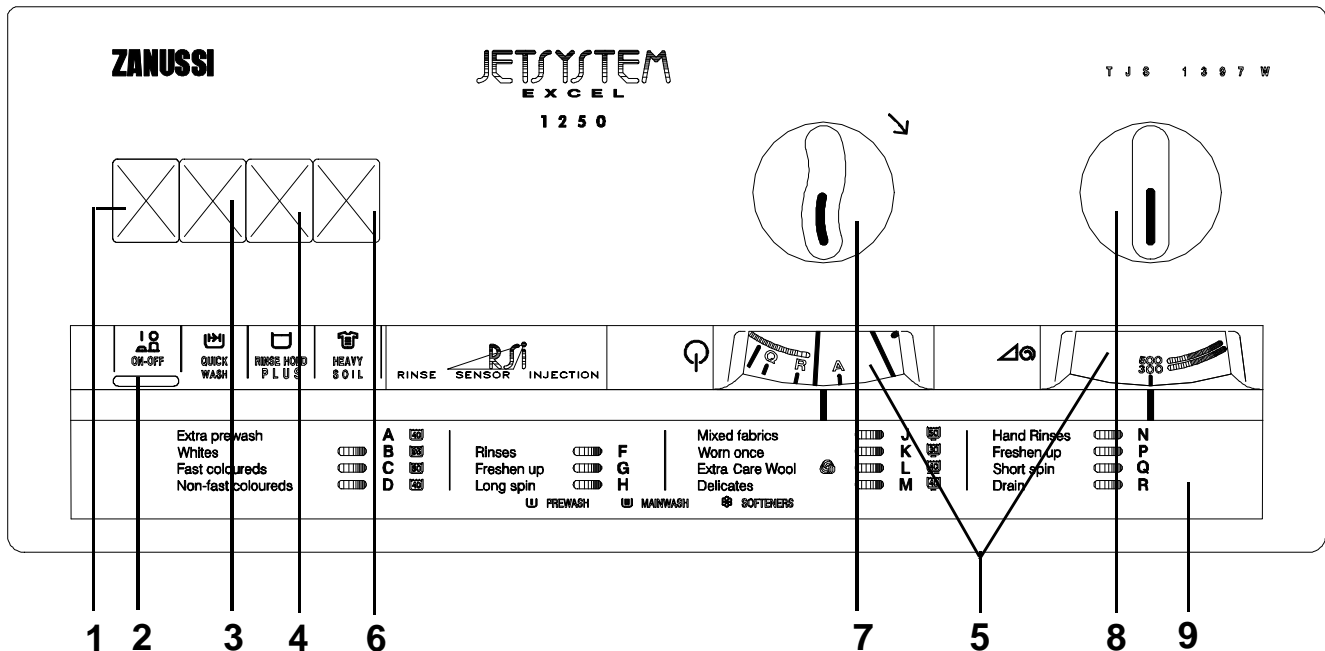

1 ON/OFF Button

To start the machine, press the ON/OFF button. The pilot light will come on. To switch off the machine, release the button by pressing it again.

2 Pilot Light

This light will come on when the machine starts operating and goes out when the ON/OFF button is released.

3 Quick Wash Button

This push button reduces the time of the washing and rinsing cycles of the cotton and synthetics programmes by approximately 60 minutes and 30 minutes respectively.

4 Rinse Hold Button

Press this button to leave the water in the drum when the wash cycle has finished. This option is available on cotton and synthetics wash programmes. The garments are left suspended in water after the final rinse which helps to prevent creasing. Do not use rinse and hold with the wool programme. Wool should be gently spin. When it is convenient to empty the machine, press this button again or select a drain or short spin programme. Ensure the ON/OFF button is in the off position before turning the dial.

5 Display Windows

6 Heavy Soil Button

By pressing the heavy soil button, the machine will take in cold water only on programmes with a water temperature of 50°-60°-95° (programmes B - C and J). These would normally be hot or hot and cold. The water is then gradually heated to the required temperature. The effect is to improve the overall wash performance, particularly on biological stains such as egg, blood and grass stains, and heavily soiled fabrics, since the longer "cool-soak" phase as the water heats up provides the right conditions for the powder and the water temperature to interact, and achieve the best possible results.

7 Programme Selector Dial

To select the required programme, turn the dial in a clockwise direction until the programme required is shown in the display window. **Do not turn the programme selector anti-clockwise (to the left). Ensure the ON/OFF button is in the OFF position when selecting a programme.**

8 Spin Speed Selector Dial

The spin speed can be varied as follows:
Cotton & linen : from 1250 to 500 rpm.
Mixed fabrics and delicates : from 650 to 300 rpm
Wool : from 1000 to 300 rpm.

9 Programme guide

Operating Sequence

Before use

Before using your appliance for the first time, we recommend you run a 95°C cotton cycle without any laundry, to remove any manufacture residue from the drum and tub.

Pour 1/2 a measure of detergent into the detergent dispenser and start the machine.

1 Load the laundry



- Lift the lid
- Open the drum with both hands by pressing the release button (A). The 2 flap doors will open outwards on a spring giving access to the drum
- Shake the laundry out loosely and place into the drum. Close the drum and shut the lid.

Before closing the lid ensure :

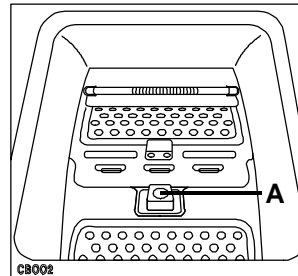
- The flap doors are fastened
- Button A is released (in the raised position).



2 Measure out the Detergent

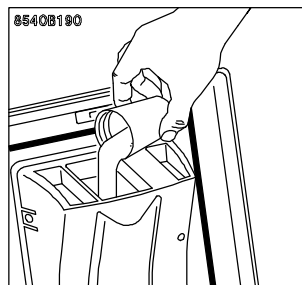

- Measure out the amount of detergent recommended by the manufacturer in the main wash compartment .
- If you are carrying out a pre-wash, pour the detergent into the pre-wash compartment .

DO NOT exceed the maximum level.

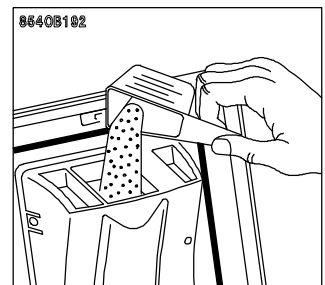

Liquid detergent
Only compartment 



Powder detergent
Compartment  (prewash)
Compartment  (wash)

3 Add Fabric softener

If required pour fabric softener into the compartment marked .

DO NOT exceed the maximum level.

4 Select Options Required

If required select options for example:

Quick Wash

Rinse Hold

Heavy Soil

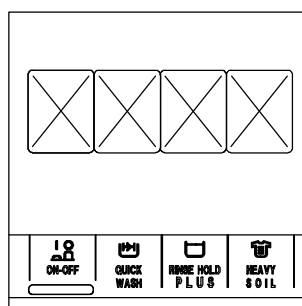

6 Select the spin speed

Turn the selector dial to the required position according to the type of the laundry :

cotton	500	600	700	800	900	1000	1100	1250
synth/del.	300	-	-	400	-	500	-	650
Wool	300	400	500	600	700	800	900	1000

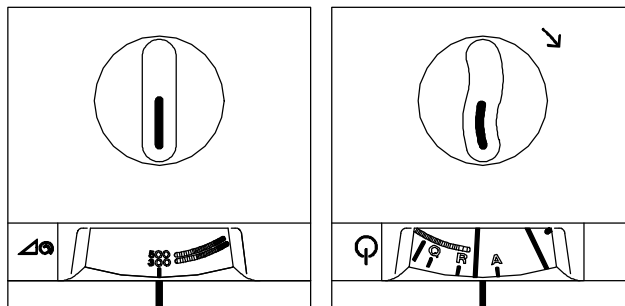

7 Select the required programme

Ensure the ON/OFF button is in the OFF position, and select the programme required by turning the selector dial clockwise.

8 Start the machine

Before starting up the machine check that :

- the appliance is plugged in
- the water supply taps are turned on
- the drain hose is correctly and securely positioned
- the lid and the detergent dispenser are closed.

Press the ON/OFF button. The pilot light will come on to show that the programme has started.

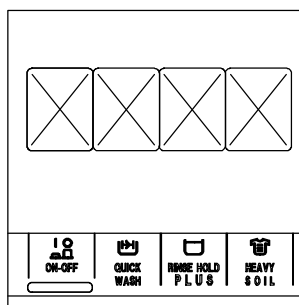

9 At the end of the Programme

When the programme has finished the machine will stop. Switch off the appliance.

If you have pressed the Rinse Hold Plus Button, the machine will stop with the water left in the tub, to prevent the fabric from creasing. To drain the water and spin, release the same button. To drain only select programme "R".

The lid is controlled by a safety device which releases 2 minutes after the end of the programme.

We recommend you unplug the appliance and turn off the water taps after use.

Washing Hints

Do **NOT** overload the machine. Weigh the laundry the first few times you use the appliance.

The average weights of the most common items are listed below as a guide:

1000g=1kg

Sheet	700-1000 g
Pillow case	100-200 g
Tablecloth	400-500 g
Serviette	50-100 g
Tea towel	70-120 g
Linen hand towel	100-150 g
Towelling hand towel	150-250 g
Towelling bath towel	700-1000g
Bath robe	1000-1500 g
Man's shirt	200-300 g
Apron	150-200 g

For Best Washing Results:

- Load the laundry loosely alternating large items with small ones.
- Sort the laundry according to the type of fabric, colour fastness and degree of soilage.
- White items should not be washed with coloured items.
- Wash new coloured items separately when washing for the first time.
- Treat stains such as paint, ink, rust and grass before washing.
- Avoid washing frayed or torn articles.
- When washing fabrics requiring different wash temperatures, always select the lowest temperature.

Always:

- Empty pockets
- Ensure buttons and zips are fastened
- Consult the care label on the garment. Only wash fabrics are designed to be machine washed.
- Place small items such as socks, laces, handkerchiefs etc in a washing bag or pillow case, as it is possible for such items to slip down between the tub and the inner drum.

Items that should not be put in the machine:

- Underwired bras.
- Garments which have been in contact with volatile or petroleum based products.
- Some duvets and eiderdowns should be washed in large commercial machines. Check with the manufacturer of the item.

Help the Environment:

To save water, energy and help protect the environment.

- Do not use a pre-wash for normally soiled washing.
- Wash full loads
- Pre-treat stains and then wash at a lower temperature.
- Only use the advised quantities of detergent and fabric softener.

Which detergent? ...

To ensure you obtain the best wash results from your appliance, it is important to use the right detergent in your everyday wash, and only detergents recommended for use in automatic machines.

To maintain the appearance of your clothes and household textiles and to make them last longer you should use different types of detergent for different washes, whether for whites, colours or delicates.

Whites

We recommend the Ariel product range which is biological and designed to provide excellent cleaning and stain removal even at low temperatures.



Non Biological

If you prefer to use a non biological detergent, which does not contain enzymes we recommend Fairy. Fairy provides good cleaning and stain removal.



Coloureds

For coloured items you should use a detergent which is designed to clean while maintaining the original colour. Ariel Color does not contain bleach and therefore helps to preserve colours.



Delicate items

When washing delicates such as woollens, you should use a product which is specially designed to care for fine fabrics. Dreft Automatic is suitable for woollens and other delicates.



Laundry Bleach

For additional stain removal you may wish to use a product such as Ace Gentle Bleach which is used in addition to your chosen detergent. Ace is suitable for all washable fabrics including silks, woollens and coloureds.



And in which form?

Not only are there different types of detergent, but they are also available in different forms. Whether you choose a powder or liquid in traditional or compact form is down to personal choice.

Traditional Powders

Pour the powder directly into the dispenser drawer. Do not sprinkle powder onto clothes in the machine drum.

Traditional Liquids

Liquid can be placed in the main wash compartment of the detergent drawer marked with the symbol , start the machine immediately upon placing the detergent in the dispenser drawer. Alternatively the detergent is measured into the specially designed dosing device* which should be placed on top of the laundry, and at the back of the machine drum.

Compact Powders and Liquids

Compact detergents (or concentrates as they are also known) are available in liquid or powder form, and generally require a smaller dosage. Follow the manufacturer's instructions to ensure the most economical usage. Pour the detergent directly into the dispenser drawer, or alternatively measure the detergent into the specially designed dosing device* which should be placed on top of the laundry, and at the back of the machine drum.

** if you use a dosing device in a washer dryer, please ensure the dosing device/ball is removed before carrying out a drying programme.*

Fabric Conditioners

These are ideal for improving "softness", and also reduce static cling on synthetics and make ironing easier. They are available in two types.

For example Lenor liquid fabric softener, for use in the **washing machine/ washer dryer**. The liquid fabric softener should be poured into the compartment marked with the symbol . Follow the manufacturer's dosage instructions and never exceed the MAX level.



Bounce conditioning sheets for use in a **tumble dryer**. We recommend the conditioning sheets are pinned (using a safety pin) to an article of laundry and placed in the tumble dryer.















Wash Care Symbols

Wash care labels inside garments recommend how to launder your clothes with the best results. The care labelling code is in line with care labelling used in the rest of Europe. The symbols used make it easy to select the correct programme on your washing machine

WASHING SYMBOL	WASH ACTION	FABRIC
	Normal (Maximum)	White Cotton or Linen without Special Finishes
	Normal (Maximum)	Cotton, Linen or Viscose without Special Finishes, Colourfast at 60°C
	Reduced (Medium)	Nylon, Polyester/Cotton, Viscose with Special Finishes, Cotton/Acrylic Mix
	Normal (Maximum)	Cotton, Linen or Viscose, Colourfast at 40°C but not 60°C
	Reduced (Medium)	Acrylics, Acetate, Triacetate, Wool mixes, Polyester/wool
	Much Reduced (Minimum)	Wool, wool mixtures, Silks
	Hand wash only	Do not machine wash
BLEACHING		
	Chlorine bleach may be used	
IRONING		
	Hot Iron	Cotton, Linen, Viscose
	Warm Iron	Polyester mixtures, Wool
	Cool Iron	Acrylic, Nylon, Polyester
DRY CLEANING		
	May be dry cleaned. Other letters and/or a bar beneath the circle will indicate the required process to the dry cleaner.	
TUMBLE DRYING		
	May be tumble dried	
	With high heat setting	
	With low heat setting	
	A cross through any symbol means "DO NOT"	

Washing Programmes

Programmes for cotton and linen

Wash programme	Degree of soil and type of laundry	Programme dial position	Description	Possible options	Max. load	Prog. time mins (1)
 EXTRA PREWASH	For heavy soiled cotton items (whites and coloureds)	A	Prewash at 40°C Short spin at 650 rpm		4,5 kg	40
 WHITES	White cotton, for example normally soiled work garments, sheets, household linen, underwear, towels.	B	Wash at 95°C 3 rinses Long spin	  	4,5 kg	135
 FAST COLOUREDS	Fast coloured cotton or linen fabrics, shirts, underwear, towels.	C(*)	Wash at 60°C 3 rinses Long spin	  	4,5 kg	130
 NON-FAST COLOUREDS	Non fast coloured cotton or linen fabrics, shirts, blouses, underwear.	D	Wash at 40°C 3 rinses Long spin		4,5 kg	90
RINSES	Separate rinse cycle for hand washed garments	F	3 rinses Long spin		4,5 kg	45
FRESHEN UP	This programme can be used for softening hand washed garments.	G	1 rinse, with fabric softener, if required Long spin		4,5 kg	20
SPIN	Separate spin for cotton and linen items.	H	Long spin		4,5 kg	12

(*) This programme at 60°C is the reference programme for the Energy label according to EEC Directive 92/75

At the end of the programme the selector dial will stop in the off position (full or half white line).

Water filing : 30°-40° programmes: cold water filing
50°-60° programmes: hot and cold water filing
95° programmes: hot and cold water filing













(1) The programme times are intended as a guide only. The actual time will vary depending on incoming water temperature and pressure.

IMPORTANT

This machine is fitted with a safety lock which prevents the lid being opened for 2 minutes after the programme has finished.

Washing Programmes

Programmes for synthetics, delicates and wool

Wash programme	Degree of soil and type of laundry	Programme dial position	Description	Possible options	Max. load	Prog. time mins (1)
 MIXED FABRICS	Synthetic or mixed fabrics, underwear, coloured garments non-shrink shirts, blouses	J	Wash at 50°C 3 rinses Short spin	  	2 kg	95
 WORN ONCE	Lightly soiled synthetic or delicate items	K	Wash at 30°C 3 rinses Short spin		2 kg	40
 EXTRA CARE WOOL 	Specially tested programme for wool garments bearing the "Pure new wool, non-shrink, machine washable" label	L	Wash at 40°C 3 rinses Short spin		1 kg	60
 DELICATES	Delicate fabrics, for example curtains	M	Wash at 40°C 3 rinses Short spin		2 kg	55
HAND RINSES	Separate rinse cycle for hand washed garments	N	3 rinses Short spin		2 kg	28
FRESHEN UP	This programme can be used for softening hand washed garments.	P	1 rinse, with fabric softener, if required Short spin		2 kg	15
SHORT SPIN	Separate spin for synthetics and delicates	Q	Draining of water and short spin		2 kg	10
DRAIN	For emptying out the last rinse water in programmes with the Rinse Hold Plus option.	R	Draining of water		–	2

At the end of the programme the selector dial will stop in the off position (full or half white line).

If the Rinse Hold option has been selected the programme will end with water remaining in the drum. Release the Rinse Hold Button to end the programme with a short spin, or turn the selector dial to "R" to drain the water.

(1) The programme times are intended as a guide only. The actual time will vary depending on incoming water temperature and pressure.

Maintenance and Cleaning

Before carrying out any maintenance or cleaning you must DISCONNECT the appliance from the electricity supply.

Descaling

The water we normally use contains lime. To help prevent the formation of lime deposits we recommend you periodically, particularly in hard water areas, use a water softening powder in the machine. Do this separately from any laundry and according to the manufacturer's instructions.

After each wash

Leave the lid and the drum open for a while. This helps to prevent mould and stagnant smells forming inside the appliance.

External Cleaning

Wipe the exterior cabinet of the appliance with a soft cloth and warm soapy water. Do not use abrasive cleaning products.

Cleaning the detergent dispenser

The detergent dispenser is very easy to remove. Press the pressure tabs located on each side of the detergent dispenser inwards and pull it up (fig.1 and fig.2).

Clean the detergent dispenser under running water with a brush or cloth (fig.3). Check that the siphons located at the back of the detergent dispenser are not obstructed (fig.4).

Replace the detergent dispenser in the notches until the hanging (fig.5).

Cleaning the drain filter

A clean filter is important for correct functioning of the machine, and should therefore be cleaned after every wash.

- Open the flapdoor (fig.6)
- To drain the residual water : Place a shallow container beneath the flapdoor. Turn the filter handle anticlockwise until the filter cap handle is vertical, any residual water will be released (fig.7).

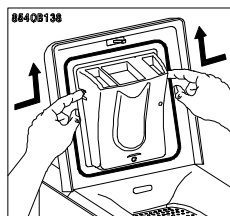

fig.1

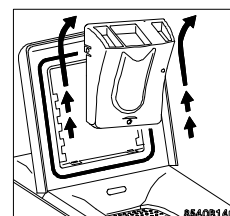

fig.2

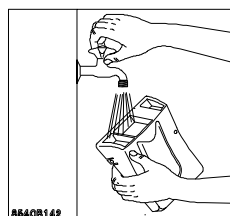

fig.3

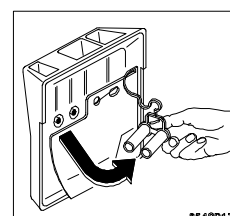

fig.4

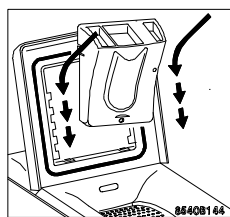

fig.5

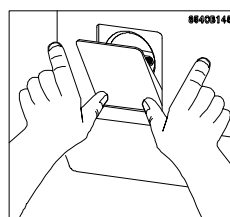

fig.6

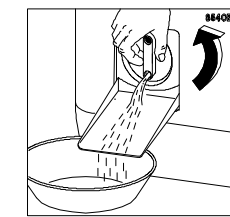

fig.7

- To clean the filter :
Unscrew the filter anticlockwise and remove.
Clean the filter carefully under a fast running tap.
Replace the filter and refit by screwing in a clockwise direction. Close the flapdoor.



Never remove the water drain filter during a wash cycle.

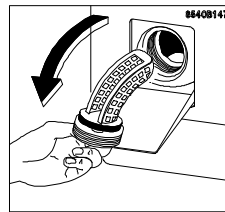

fig.8

The dangers of freezing

If the machine is exposed to temperatures below 0°C, certain precautions should be taken.

- Turn off both water taps.
- Select a wash programme and run for a few seconds to relieve the pressure in the hoses. Unscrew the hoses and drain them into a bowl at ground level.
- Unhook the drain hose from the rear support and position the end in a bowl at ground level to drain.
- When intending to use the machine again, re-connect the hoses and make sure that the room temperature is above 0°C.

Something Not Working

If your appliance is not working correctly, please carry out the following checks before calling out an engineer.

SYMPTOM	POSSIBLE CAUSE	SOLUTION
The machine does not start up	<ul style="list-style-type: none"> ■ The ON/OFF button has not been depressed. ■ The lid is not properly closed ■ The appliance is not plugged in ■ There is no electricity supply from the wall socket ■ The programme selector dial is not correctly positioned 	<ul style="list-style-type: none"> ■ Press the ON/OFF button ■ Close the lid ■ Plug in the appliance ■ Check the fuse ■ Turn the selector dial to the required programme
The machine does not fill	<ul style="list-style-type: none"> ■ The water is not turned on ■ The water supply has been cut off ■ The inlet hose is kinked ■ The water pressure is too low ■ The water inlet filter is clogged 	<ul style="list-style-type: none"> ■ Turn on the water ■ Wait until the water supply is restored ■ Straighten the inlet hose ■ Consult a qualified plumber ■ Clean the filter
The machine empties as it fills	<ul style="list-style-type: none"> ■ The end of the drain hose is too low ■ The end of the drain hose is submerged in water 	<ul style="list-style-type: none"> ■ Position the drain hose at the correct height (between 70 and 100 cm) ■ Re-position the drain hose so it is not submerged
The machine does not drain or spin	<ul style="list-style-type: none"> ■ The Rinse Hold Plus button has been pressed ■ The drain filter is clogged ■ The drain hose is bent ■ The drainage system pipes are blocked ■ The drain hose extension is incorrect ■ The wash load is unbalanced 	<ul style="list-style-type: none"> ■ Release the Rinse Hold Plus button ■ Clean the filter ■ Straighten the hose ■ Consult a plumber ■ Consult a plumber ■ Reload the washing and select a spin programme
The machine leaks or overfills	<ul style="list-style-type: none"> ■ Too much detergent ■ Unsuitable detergent ■ The detergent dispenser is blocked ■ The end of the drain hose is not correctly positioned 	<ul style="list-style-type: none"> ■ Reduce the quantity of detergent ■ Use only detergent for automatic washing machines ■ Clean the dispenser ■ Re-position the drain hose
The machine vibrates or is noisy	<ul style="list-style-type: none"> ■ The internal packing and/or transit bolts have not been removed ■ The wash load is unevenly distributed ■ The machine is overloaded 	<ul style="list-style-type: none"> ■ Remove internal packing/transit bolts ■ See hints and tips section ■ Observe the maximum loads quoted for the programme
The lid does not open	<ul style="list-style-type: none"> ■ The safety device has locked it 	<ul style="list-style-type: none"> ■ Wait 2 minutes after programme end before opening the lid

If after the above checks, there is still a fault, call your local Zanussi Service Force Centre.

Service & Spare Parts

If you require an engineer or wish to purchase spare parts contact your local Zanussi Service Force Centre by telephoning:

0870 5 929929

Your telephone call will be routed to the Service Centre covering your post code area. Further information can be found in the accompanying customer care booklet and also in your telephone directory under "Z". When you call the Service Force Centre please make sure you give the model and serial number of the appliance.

This information can be found on the rating plate (see picture) or on the guarantee card.

In-guarantee customers should ensure that the above checks have been made as the engineer will make a charge if the fault is not a mechanical or electrical breakdown. Please note that proof of purchase is required for any in-guarantee service calls.

Customer Care

For general enquiries concerning your Zanussi appliance or for further information on Zanussi products, please contact our Customer Care Department by letter or telephone as follows:

Customer Care Department
Zanussi
55-77 High Street
Slough
Berkshire
SL1 1DZ

Tel 08705 727727

Typ.
Prod. N*
Ser. Nr.

Peace of Mind for Twelve Months

Standard guarantee conditions

We, Zanussi Limited, undertake that if within 12 months of the date of the purchase this Zanussi appliance or any part thereof is proved to be defective by reason only of faulty workmanship or materials, we will, at our option, repair or replace the same **FREE OF ANY CHARGE** for labour, materials or carriage on condition that:

- The appliance has been correctly installed and used only on the electricity supply stated on the rating plate
- The appliance has been used for normal domestic purposes only, and in accordance with the manufacturer's instructions
- The appliance has not been serviced, maintained repaired, taken apart or tampered with by any person not authorised by us

All service work under this guarantee must be undertaken by a Zanussi Service Force Centre.

Any appliance or defective part replaced shall come the Company's property.

This guarantee is in addition to your statutory and other legal rights.

Home visits are made between **8.30 am** and **5.30 pm** Monday to Friday. Visits may be available outside these hours in which case a **premium** will be charged.

Exclusions

This guarantee does not cover:

- Damage or calls resulting from transportation, improper use or neglect, the replacement of any light bulbs or removable parts of glass or plastic.
- Costs incurred for calls to put right an appliance which is improperly installed or calls to appliances outside the United Kingdom.
- Appliances found to be in use within a commercial environment, plus those which are subject to rental agreements.
- Products of Zanussi manufacture which are not marketed by Zanussi Limited.

European Guarantee

If you should move to another country within Europe then your guarantee moves with you to your new home subject to the following qualifications:

- The guarantee starts from the date you first purchased your product
- The guarantee is for the same period and to the same extent for labour and parts as exists in the new country of use for this brand or range of products
- This guarantee relates to you and cannot be transferred to another user
- Your new home is within the European Community (EC) or European Free Trade Area
- The product is installed and used in accordance with our instructions and is only used domestically, i.e. a normal household
- The product is installed taking into account regulations in your new country

Before you move please contact your nearest Customer Care centre, listed below, to give them details of your new home. They will then ensure that the local Service Organisation is aware of your move and able to look after you and your appliances.

France	Senlis	+33 (0)3 44 62 29 99
Germany	Nurnberg	+49 (0)911 323 2600
Italy	Pordenone	+39 (0)1678 47053
Sweden	Stockholm	+46 (0)8 738 79 50
UK	Slough	+44 (0) 1753 219897

Installation Instructions

 It is dangerous to alter the specifications or attempt to modify this product in any way.

 Care must be taken to ensure that the appliance does not stand on the electrical supply cable.

 Any electrical work required to install this appliance should be carried out by a qualified electrician or competent person.

 Any plumbing work required to install this appliance should be carried out by a qualified plumber or competent person.

Technical Specifications

Dimensions	Height with panel Height without panel Width Depth	895 mm 850 mm 397 mm 600 mm
Power supply voltage / frequency		230 V - 240 V / 50 Hz
Total power absorbed		2300 W - 2400 W / (10 A)
Heater rating		1950 W
Water pressure	minimum maximum	5 N/cm ² (0,5 kg/cm ²) 80 N/cm ² (8 kg/cm ²)
Maximum load	Cotton Synthetics/delicates Wool	4,5 kg 2 kg 1 kg
Maximum spinning speed		1250 rpm
Electrical consumption (washing at 60°C)		0,85 kWh

 This appliance complies with the following EC Directive :
 - 72/23/EEC of 19.02.1973 - Low-Voltage Directive
 - 89/336/EEC of 03.05.1989 (including Amentment Directive 92/31/EEC) - EMV Directive.

Unpacking

Before installing the machine the packing and transit bolts must be removed. The transit packaging is red for ease of identification. Please retain the packing and transit bolts for re-use in case the machine is to be transported again.

- Unpack the appliance. Tilt the appliance backwards. Remove the polystyrene base, by turning the appliance one quarter turn. Remove the base (fig. 1).
- Open the lid and remove the polystyrene block and wedges securing the drum. Close the lid (fig. 2).
- Using a spanner, remove the two transit bolts (A) (fig. 3).
- The holes which are now visible must be filled with the plugs (B) provided (fig. 4).
- Retain the polystyrene block and transit bolts for future use (fig. 5).
- To enable the appliance to be pushed further into the recess, the plastic crossbar holding the hoses at the back of the appliance can be cut off (fig. 6).

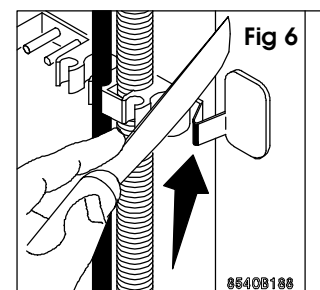
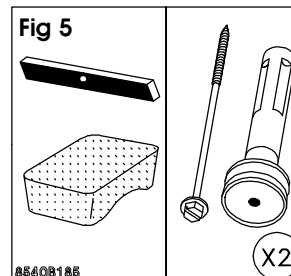
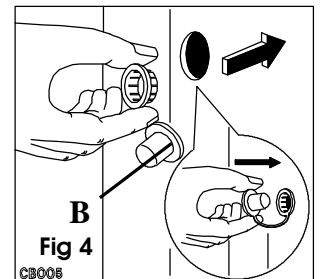
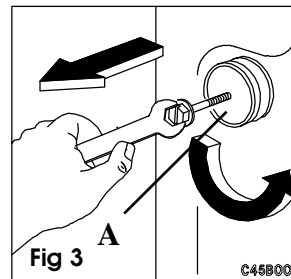
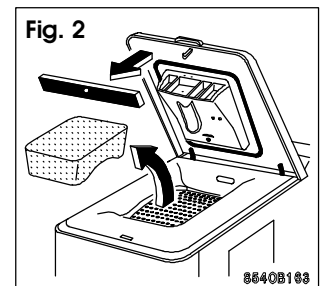
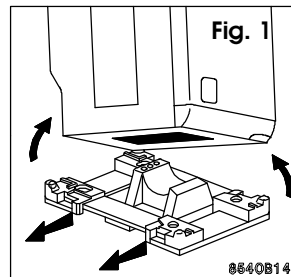

Positioning

- The installation surface must be clean dry and level
- Do not install on deep pile carpet.
- Do not install the appliance in locations where the temperature may fall below freezing
- Please ensure that when the appliance is installed it is easily accessible for the engineer in the event of a breakdown

Levelling the Appliance

- The appliance must be levelled using the adjustable feet.
- Adjust the feet so that the appliance is level. The appliance must not rock when weight is applied.
- Check the appliance is level using a spirit level.

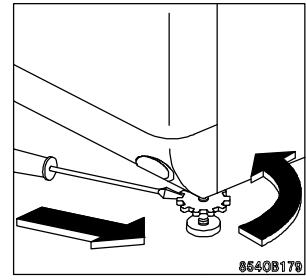
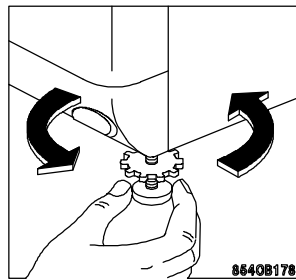

Moving the appliance

To move the washing machine, release the wheels by pulling the lever at the bottom of the machine. Pull the lever to the right and move the machine to the required position. When the machine has been correctly positioned, push the lever back to its original position.

Do not operate the machine with the wheels released.

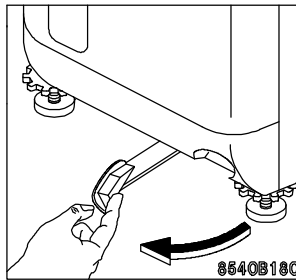

Warning

The machine should NOT be placed on deep pile carpeting.

Note

Please ensure that when the appliance is installed it is easily accessible for the engineer in the event of a breakdown.

Water connection

This appliance is designed to be permanently plumbed into your home's water supply and drainage system.

Water inlet

The appliance has two inlet hoses, hot and cold with female 3/4" BSP thread connectors. If this connection is not compatible with the plumbing of the existing installation, a variety of connectors are available from good hardware stores and plumbers merchants to suit most domestic plumbing.

Any alterations to your existing plumbing must be carried out by a competent person, or qualified plumber.

The inlet hoses on the back of the appliance are colour coded. Connect the hose with blue printed text to the cold water supply and the hose with red printed text to the hot water supply.

Before connecting the hoses be sure to fit the washers supplied.

If only a cold water supply is available connect the two hoses to a cold water outlet by means of a "Y" connection piece. (Available from your local D.I.Y. Store).

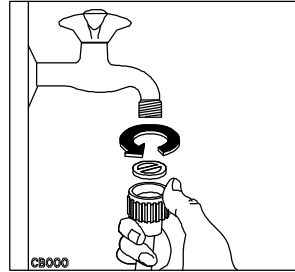

Water Drainage

The appliance drain hose should hook into a standpipe, with an internal diameter of approximately 38mm (see diagram) thus ensuring there is an air break between the drain hose and standpipe. The hook in the drain hose is formed using the plastic "U-piece" supplied. The "U-piece" also has a retaining eye to secure the outlet hose and prevent it from slipping off its location.

When discharging into a standpipe ensure that the top of the curve in the hose end is no more than 100cm and no less than 70cm above floor level. The upright standpipe should have a minimum length of 30cm (12") from the bottom of the elbow to the top of the pipe (see diagram). Make sure that it is designed in such a way that the end of the drain hose cannot be covered with water.

If you intend the drain hose from the washing machine to empty into a sink, make sure that the sink is empty and that the plug hole is not blocked. Use the plastic "U-piece" supplied. The "U-piece" also has a retaining eye to secure the outlet hose and prevent it from slipping off its location. The force of draining water may force the hose out of the sink.

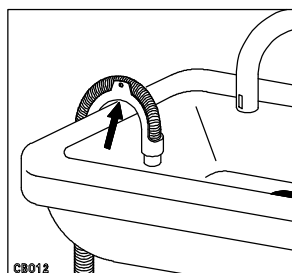
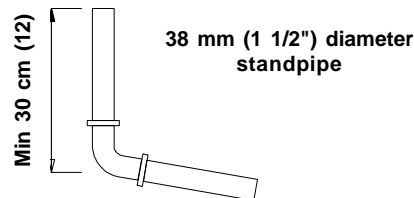
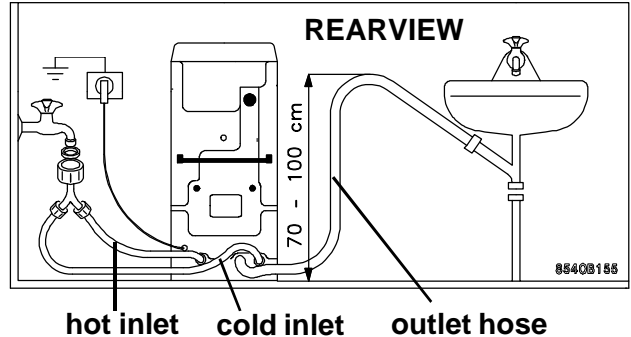

Electrical Connection

Any electrical work required to install this appliance should be carried out by a qualified electrician or competent person.

WARNING: THIS APPLIANCE MUST BE EARTHED.



The manufacturer declines any liability should these safety measures not be observed.

Before switching on, make sure the electricity supply voltage is the same as that indicated on the appliance rating plate. The rating plate is located at the back of the appliance. The appliance is supplied with a 13amp plug supplied, a 13amp ASTA approved (BS1362) fuse must be used.

Should the plug need to be replaced for any reason.

The wires in the mains lead are coloured in accordance with the following code:

Green and Yellow	: Earth
Blue	: Neutral
Brown	: Live

The wire coloured green and yellow must be connected to the terminal marked with the letter "E" or by the earth symbol or coloured green and yellow.

The wire coloured blue must be connected to the terminal "N" or coloured black.

The wire coloured brown must be connected to the terminal marked "L" or coloured red.

Upon completion there must be no cut, or stray strands of wire present and the cord clamp must be secure over the outer sheath.

WARNING:



A cut off plug inserted into a 13 amp socket is a serious safety (shock) hazard. Ensure that the cut off plug is disposed of safely.

Permanent connection

In the case of a permanent connection it is necessary that you install a double pole switch between the appliance and the electricity supply (mains), with a minimum gap of 3mm between the switch contacts and of a type suitable for the required load in compliance with the current electrical regulations. The switch must not break the yellow and green earth cable at any point.

146 1250 00

